

# Ease S1 Open-Top Self-Cleaning Litter Box

Model: CB01

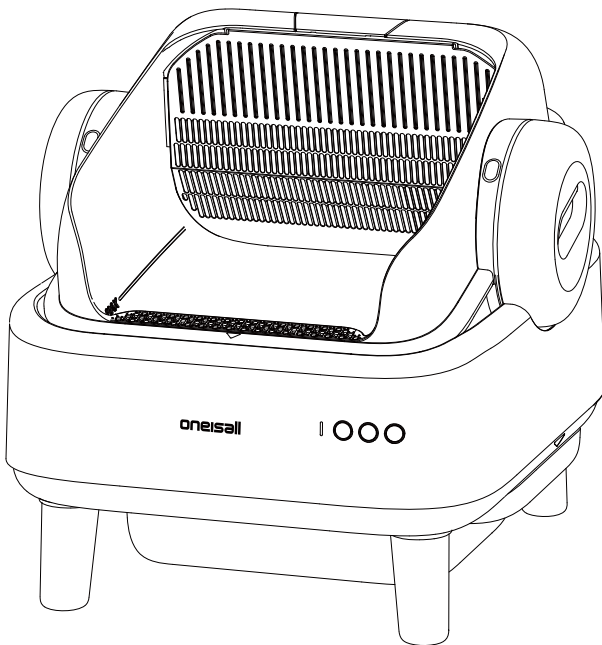

User Manual

READ AND SAVE THESE INSTRUCTIONS

ON-D223

# Safety Instructions

---

## Improper use may result in injury or product damage.

1. This product is not suitable for kittens under 6 months of age or weighing less than 2.6 lb (1.2 kg).
2. Use mineral/bentonite clumping litter only. Do not use crystal, corn, or cassava-based litter.
3. Place the unit on a flat, hard, stable surface. Keep 2–4 in (5–10 cm) of clearance on all sides. Do not let it lean against any objects. Do not use on carpet.
4. Install indoors, away from direct sunlight and open flames.
5. The product uses low-voltage power. Keep the power adapter and cord secured and out of reach of pets and children. If a pet attempts to chew the cord, unplug the unit immediately and correct the behavior before using it again.
6. Do not place the device in excessively hot or humid environments.
7. Use only the original power adapter. Non-original adapters may cause damage or create safety hazards.
8. Do not scratch the full-cover litter pad with sharp objects.
9. Avoid tilting or tipping over the device to prevent accidents or damage.
10. Never submerge the base or the left/right drive boxes and do not rinse them directly with water.
11. The base contains weight sensors. Lift gently; do not push or drag the unit.
12. Unplug the power cord before transporting or if the product will not be used for an extended period.
13. Children must use under adult supervision.
14. Repairs must be performed by qualified personnel.
15. Before traveling, ensure the litter is sufficient and the waste drawer has enough capacity.
16. This appliance can be used by children aged from 8 years and above and persons with reduced physical, sensory or mental capabilities or lack of experience and knowledge if they have been given supervision or instruction concerning use of the appliance in a safe way and understand the hazards involved
  - children shall not play with the appliance
  - cleaning and user maintenance shall not be made by children without supervision

## FCC Statement:

---

This device complies with part 15 of the FCC Rules. Operation is subject to the following two conditions:

1. This device may not cause harmful interference, and
2. This device must accept any interference received, including interference that may cause undesired operation.

# Use Precautions

---

---

<b>Helping Your Kitty Love the New Box</b>	<b>01</b>
<b>Product Overview</b>	<b>02</b>
<b>Protection Mechanisms</b>	<b>03</b>
<b>Package Contents</b>	<b>04</b>
<b>Specifications</b>	<b>05</b>
<b>Installation Instructions</b>	<b>05</b>
<b>Button Operations</b>	<b>08</b>
<b>Disassembly (for Cleaning)</b>	<b>10</b>
<b>Troubleshooting</b>	<b>12</b>
<b>Hazardous Substances Table</b>	<b>13</b>
<b>Contact Us</b>	<b>14</b>
<b>GPSR Product Information</b>	<b>15</b>

# Helping Your Kitty Love the New Box

---

## Step 1: Put Both Boxes Together

Place the Ease S1 next to your cat's current litter box.

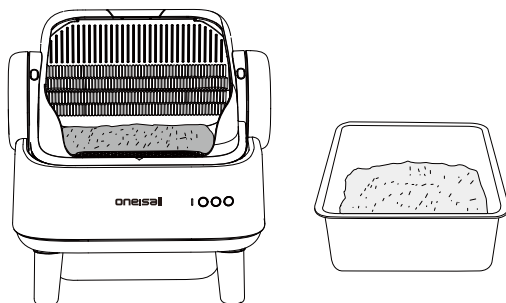

## Step 2: Add a Little Used Litter

Sprinkle some used litter from the old box into the new one.

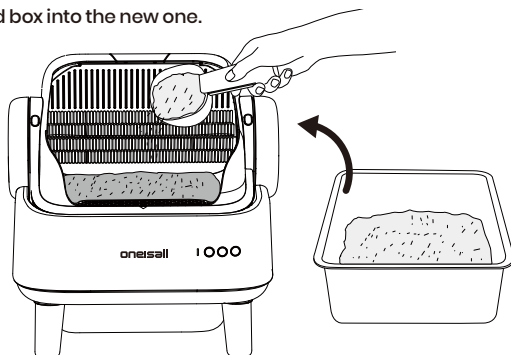

## Step 3: Switch Slowly

Keep the old box until your cat fully uses the new one, then phase it out.

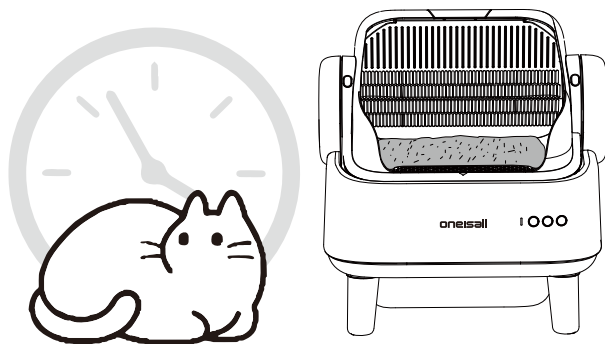

# Product Overview

---

Stainless Steel Litter Guard

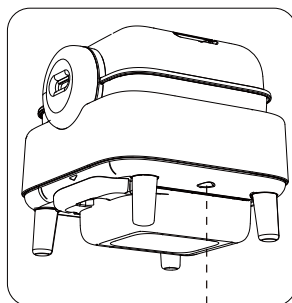
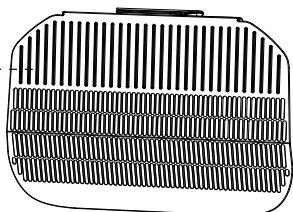

Power Port

Litter Tray Lid

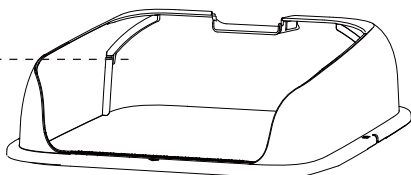

Full-Cover Litter Pad

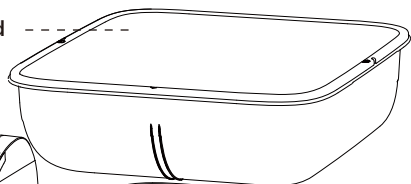

Left Drive Boxes



Right Drive Boxes



Litter Tray

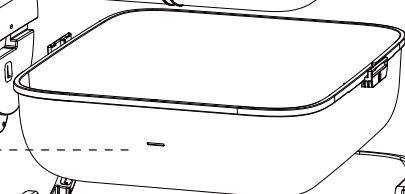



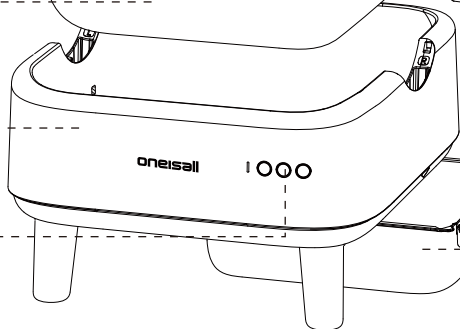

Base Unit

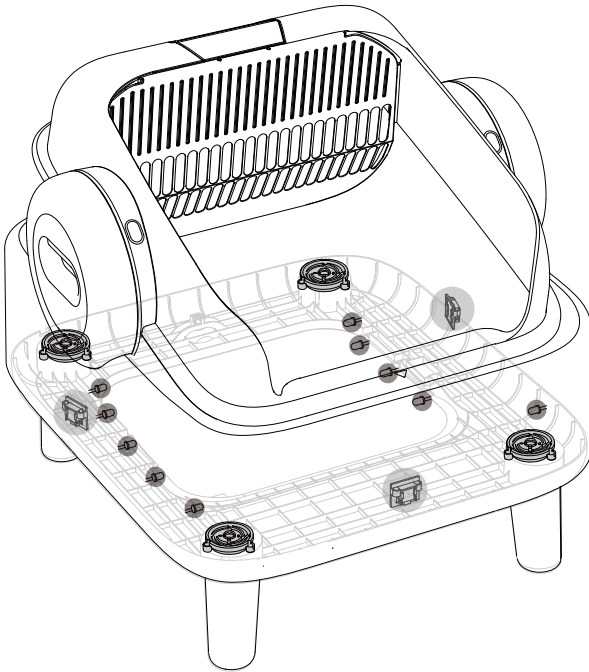

Control Panel

Waste Drawer



-  Radar Sensor
-  Infrared Sensor
-  Weight Sensor

## Protection Mechanisms

---

Protection	Priority	Description
Radar	Level 1	The device stops if a moving object is near. Resumes after object leaves.
Weight	Level 2	The device pauses if any object over 2.6 lb enters the box and resumes once it leaves.
Infrared	Level 3	The device stops rotation if front/back of the base sensors are blocked. Resumes after unblocked.
Motor Stall	Level 4	The device stops and briefly reverses if motor encounters resistance. Resumes when clear.



### NOTE

Higher priority numbers = higher protection priority

# Package Contents

---

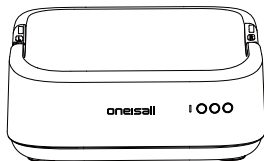

Base Unit ×1

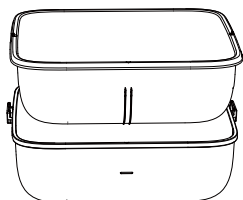

Full-Cover Litter Pad &  
Litter Tray ×1

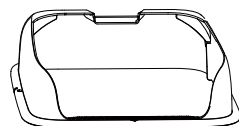

Litter Tray Lid ×1

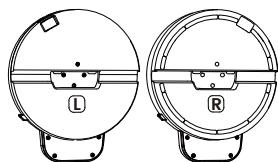

Left/Right Drive Box ×1

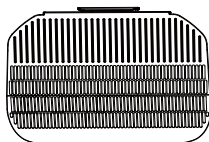

Stainless Steel Litter Guard ×1



Waste Drawer ×1



Support Legs ×4

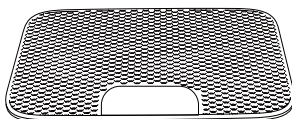

Cat Litter Mat ×1

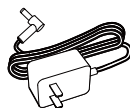

Power Adapter ×1



Waste Bag ×2

# Specifications

---

Product Name:	Ease SI Open-Top Self-Cleaning Litter Box
Product Model:	CB01
Rated Voltage:	12V  2A
Rated Power:	10W
Waste Drawer Capacity:	11L
Material:	ABS, stainless steel
Operating Temperature:	5–40 °C (41–104 °F)
Suitable for:	Cats ≥ 6 months or ≥ 1.2 kg (2.6 lb)
Dimensions (L × W × H):	22.05 × 23.03 × 21.97 in (560 × 585 × 558 mm)

## Installation Instructions

---



### Check Operating Environment:

1. Place the device on a flat, hard surface.
2. Keep 2–4 in (5–10 cm) clearance from walls and furniture on all sides.
3. Do not use on carpet.

### 1. Install the Supporting Legs:

- ① Match four leg's holes to the base's pins.
- ② Press firmly into place.

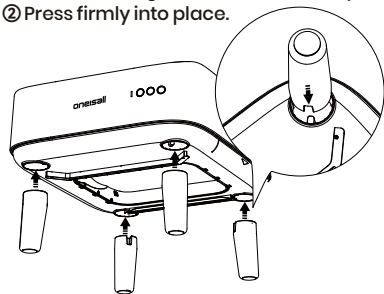

### 2. Attach the Waste Bag:

- ① Fit the Oneisall waste bag over the four corners of the waste drawer and smooth it flat.



### 3. Install the Waste Drawer:

- ① Align the arrow mark on the drawer and base, then slide the drawer into the base.
- ② It can be installed on either left/right side.

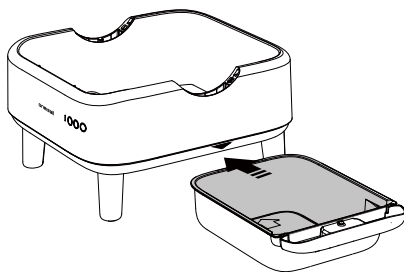

### 4. Install the Litter Tray Lid:

- ① Take the litter tray lid out of the litter tray and flip it over.

- ② Align the ▼ marks and press the lid firmly into place.

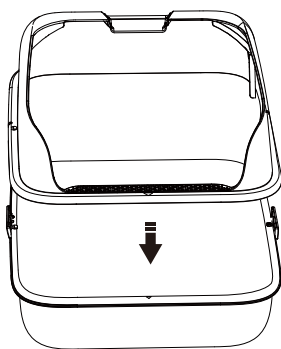
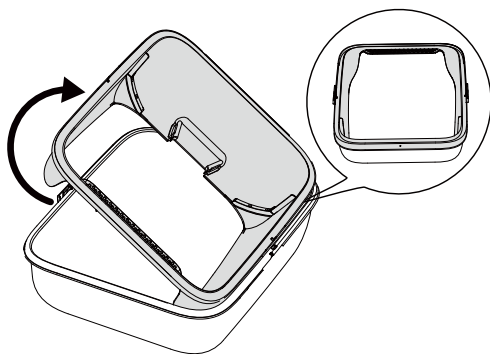

### 5. Install the Left and Right Drive Boxes:

- ① Match "L" and "R" markings with the litter box.
- ② Align with grooves, and press until you hear a click.

### 6. Install the Litter Tray:

- ① Align the tray with the side slots and place it down.
- ② Make sure the tray entrance faces the control-panel side of the base.

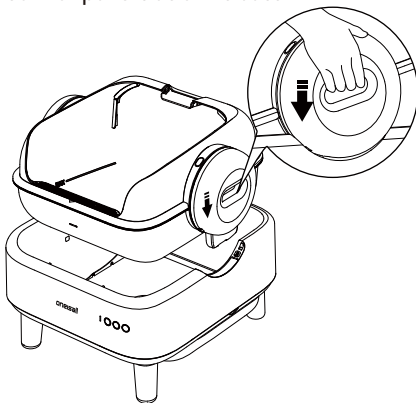
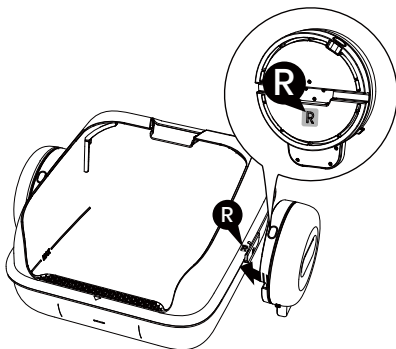

## 7. Install the Litter Guard:

① Put the litter guard in sideways.

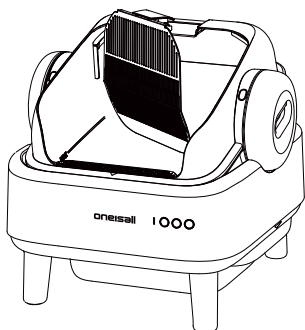

② Align the litter guard with the slot and insert.

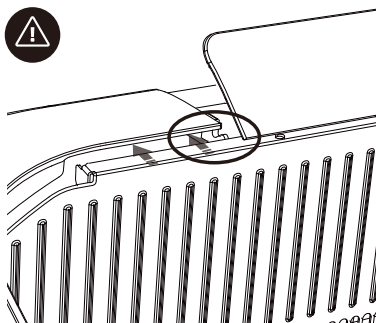

③ Press it down to lock in place.

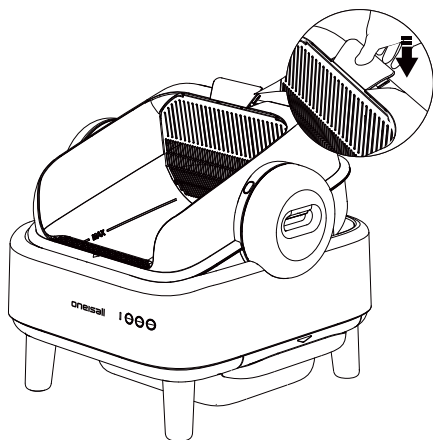

## 8. Connect Power:

① Plug in the adapter and connect to a power outlet.

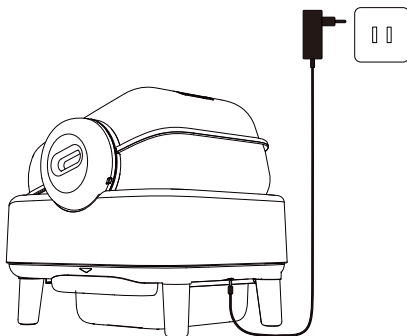

## 9. Add Cat Litter & Level:

- ① Pour litter below the MAX line.
- ② Press "Level" to smooth surface.

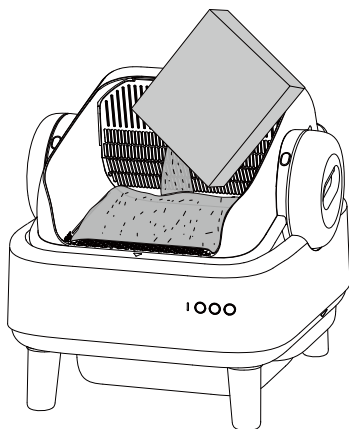

## Button Operations

---



### Manual Cleaning

- Press once to start cleaning.
- During cleaning, press Clean to pause. Press again to resume.
- Avoid pressing the button repeatedly.



### Manual/Auto Mode

- Press and hold 3 seconds: Toggle between Auto Cleaning Mode and Manual Cleaning Mode.

### Mode Behavior

- Auto Cleaning Mode (Default):
  1. After the cat leaves the litter box, the unit detects the exit.
  2. The unit waits 5 minutes to let clumps form and reduce sticking.
  3. The unit then starts cleaning again, rotating to drop the clumps into the waste drawer.
- Manual Cleaning Mode: The unit does not clean automatically. Press Clean to start each cycle.



## Recommendation:

For pregnant or nursing cats, use Manual Cleaning Mode for safety and comfort.







### Level (Cat Litter Leveling)

- Press once: Levels and smooths the litter surface after adding new litter.
- During leveling, press Level to pause. Press again to resume.
- Avoid pressing the button repeatedly.

Do not add litter during leveling. Doing so will pause the device.  
Once the area is safe, press Level again to complete the cycle.

### LED Indicator Table:

Indicator	Status	Description
 Manual Cleaning	White LED On	Cleaning in progress
	White LED Flashing	Cleaning paused
	Red LED On	Waste drawer is full — empty immediately
	Red LED Flashing	Waste drawer not installed properly
 Manual Mode	White LED On	Manual Mode ON — automatic cleaning disabled
	White LED Off	Auto Mode active — cleans automatically after cat use
 Cat Litter Leveling	White LED On	Leveling in progress
	White LED Flashing	Leveling paused
 Status Light	White LED On	Standby (ready)
	Orange LED On	Movement detected (pet nearby or entering)
	Red LED On	Cat in unsafe position — check the device
Clean + Manual + Leveling flashing together	All Red Lights Flashing	Device not fully assembled. Ensure all parts are securely installed: <ul style="list-style-type: none"><li>• Left &amp; right drive boxes</li><li>• Litter tray</li><li>• Stainless steel litter guard</li><li>• Full-cover litter pad</li></ul>

# Disassembly (for Cleaning)

## 1. Remove the Litter Guard:

- ① Lift the handle.
- ② Tilt and remove the litter guard.

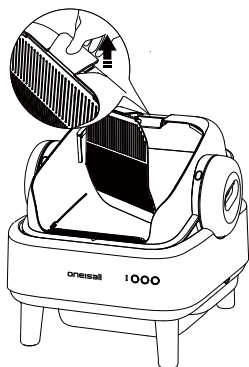

## 2. Remove the Litter tray:

- ① Press both orange latches simultaneously.
- ② Lift the litter tray straight up to detach it from the base.

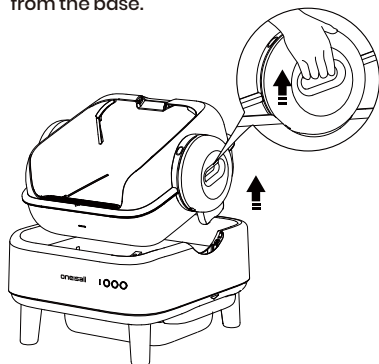

## 3. Detach the Drive Boxes:

- ① Press the side release buttons. Pull out the Left and Right Drive Boxes.

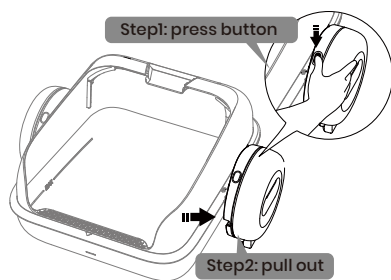

## 4. Separate-Disassemble the Litter Tray Parts:

- ① Detach the litter tray, lid, and full-cover litter pad.

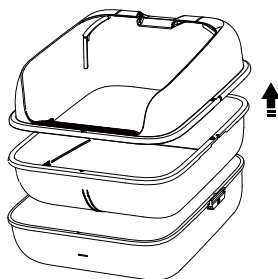

**Warning:**  
Do not rinse the drive boxes. Wipe with a damp cloth only.

## Cleaning & Maintenance

### 1. Litter Guard:

- ① The litter guard can be removed anytime. Rinse with clean water or scrub gently with a soft brush.

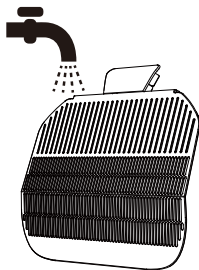

### 2. Waste Drawer:

- ① Pull the waste drawer out using the PULL handle at the base.
- ② Remove and tie up the waste bag, then dispose of it.

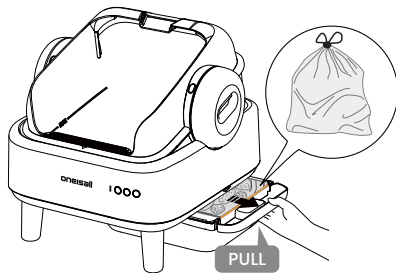

**Tip:**  
Empty every 3–5 days to reduce odors and bacterial growth.

### 3. Litter Tray:

- ① Empty any remaining litter.
- ② Rinse the full-cover litter pad, litter tray, and lid with water or a soft brush.



### 4. Base Unit

- ① Do not rinse or submerge the base. If dirty, wipe with a damp cloth and dry.

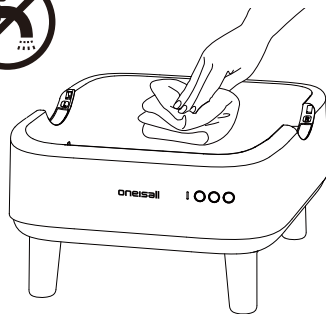

**Tip:**  
Cats prefer a clean environment. Clean the full tray set (including the Full-Cover Litter Pad) at least once per month to minimize residual odors.

# Troubleshooting

---

Problem	Cause
Manual Cleaning — Red LED On	<ol style="list-style-type: none"><li>1. Check if the waste drawer is full. If full, replace the waste bag.</li><li>2. Make sure the waste bag is laid flat and not blocking the infrared sensors.</li><li>3. Gently wipe the infrared sensors between the base and waste drawer with a clean cloth or cotton swab.</li></ol>
Manual Cleaning — Red LED Flashing	<ol style="list-style-type: none"><li>1. Check whether the waste drawer is fully seated. Remove and reinstall it.</li><li>2. Inspect the waste-drawer rails under the unit for debris. Clear any obstructions and reinstall the drawer.</li></ol>
All Red LED Flashing (Clean + Manual + Leveling flashing together)	Ensure all components (left/right drive boxes, litter tray, stainless steel litter guard, and full-cover litter pad) are correctly installed in their positions.
Status Light — Orange LED On	<ol style="list-style-type: none"><li>1. Make sure the unit is placed on a flat, hard surface with no debris underneath.</li><li>2. Ensure the unit is not leaning against walls or near large running appliances.</li><li>3. Check that all four support legs are firmly touching the ground.</li><li>4. Inspect the litter chamber for any objects that may be interfering.</li><li>5. After adding litter, press Level to recalibrate the weight.</li></ol>
Litter Tray Rotates Repeatedly	Check whether the litter level exceeds the MAX line inside the litter tray. Overfilling may cause overload.
Litter Tray Not Rotating / Stops During Rotation	<ol style="list-style-type: none"><li>1. Ensure both the power adapter and DC plug are firmly connected, then power cycle the unit.</li><li>2. Check whether the status light is showing any alerts.</li></ol>
Clean Litter Falling Into Waste Drawer	<ol style="list-style-type: none"><li>1. Confirm that the litter guard size matches your litter type: Small-particle litter (e.g., mineral / bentonite clumping litter): Small-hole guard (Included) Long-strip litter (e.g., tofu litter): Large-hole guard (Not included: For assistance, please contact customer support@oneisall.com.)</li><li>2. If you're unsure which guard you have, please contact customer support.@oneisall.com</li></ol>
Where to Find Replacement Accessories	<b>Waste Bag</b> — ASIN: B0G46Z5NTP <b>Full-Cover Litter Pad</b> — ASIN: B0G479JSTX <b>Litter Guard</b> — ASIN: B0G47DMBWM <b>Litter Box Step</b> — ASIN: B0G479PBTZ

# Hazardous Substances Table

Part Name	Hazardous Substances or Elements					
PCB Assembly	Lead (Pb)	Mercury (Hg)	Cadmium (Cd)	Hexavalent Chromium (Cr <sup>6+</sup> )	Polybrominated Biphenyls (PBB)	Polybrominated Diphenyl Ethers (PBDE)
Plastic	○	○	○	○	○	○
Metal	○	○	○	○	○	○
Accessories	○	○	○	○	○	○



### Notes:

This table is prepared in accordance with the standard SJ/T 11364.

① “0” indicates that the content of the hazardous substance in all homogeneous materials of this part is below the limit requirements specified in GB/T 26572.

② “X” indicates that the content of the hazardous substance in at least one homogeneous material of this part exceeds the limit requirements specified in GB/T 26572.

## Contact Us

---

### WE ARE READY TO HELP

Oneisall offers a standard 2-year warranty. If you have any issues with your Oneisall product, please do not hesitate to contact us. Be sure to include your proof of purchase, model number, and any relevant photos or videos in your message to expedite the process. Our Oneisall support team is available 7 days a week and will respond to your inquiry within 24 hours. Thank you for choosing Oneisall.

Please note that the Oneisall warranty does not apply to used products or purchases made from unauthorized sellers. It's important to be aware that the warranty also does not cover consumable parts such as waste bags, full-cover litter pad, cat litter mat, and similar items. These parts may require regular replacement or maintenance.

- ✉ [support@oneisall.com](mailto:support@oneisall.com)
- 📞 +1 877-522-8578 (US) Mon-Fri 8am-5pm (PST)
- 🌐 [www.oneisall.com](http://www.oneisall.com)



Troubleshooting



Assembly &  
Disassembly Tutorial



@Oneisall Official

# GPSR Product Information

---



Name: Apex CE Specialists GmbH  
Add: Grafenberger Allee 277-287,40237 Düsseldorf,DE  
Contact Person: Wells Yan  
Tel: +353212066339  
E-Mail: Info@apex-ce.de



Name: APEX CE SPECIALISTS LIMITED  
Add: 6f East Union Street, Manchester, England, M16 9AE  
Contact: Wells  
Tel: +441616371080  
E-Mail: Info@apex-ce.com

## GPSR-Manufacturer Info:

Business Name: Shenzhenbenfendianzishangwuyouxiangongsi  
Manufacturer's Address: CN, 518000, GuangDong Sheng, Shenzhen, Longhua District, Minxin Community Bishui Longting Building 6 Unit, 7B  
Tel: +86 185 6587 6424  
E-Mail: topservice4u@hotmail.com

Product Name: Ease S1 Open-Top Self-Cleaning Litter Box  
Brand: Oneisall  
Product Model: CB01  
Rated Voltage: 10W  
Input: 12V  2A





Any problems you have, please contact us :  
[support@oneisall.com](mailto:support@oneisall.com)



Assembly &  
Disassembly Tutorial



Troubleshooting



oneisall support